

**ANTENNA RADIATOR**

Type Slotted waveguide array open radiator  
 Length 4 ft (XN12A) or 6 ft (XN13A)  
 Rotation Speed 24/36/48 rpm  
 Wind Load 70 kt relative wind  
 Beamwidth  
 4 ft (XN12A): Hor. 1.9°, Vert. 22°  
 6 ft (XN13A): Hor. 1.35°, Vert. 22°

**RF TRANSCEIVER**

Frequency 9410 ± 30 MHz (X-band)  
 Output Power  
 FR-8062: 6 kW  
 FR-8122: 12 kW  
 FR-8252: 25 kW

**DISPLAY**

Screen Size 12.1" color LCD  
 Effective Viewing Area 184 (H) x 246 (V) mm  
 Pixel Number 600 (H) x 800 (V), SVGA  
 Effective Diameter 184 mm  
 Echo Colors 32 levels  
 Echo Trail Gradation 7 levels  
 Display Modes Head-up, Course-up\*\*, North-up\*\*, True motion\*\*\*  
 \*\* Heading data required  
 \*\*\* Heading and speed data required

Range Units nm, sm, km  
 Range Scales and Range Ring Intervals (nm)  
 Range: 1/8, 1/4, 1/2, 3/4, 1, 1.5, 2, 3, 4, 6, 8, 12, 16, 24, 36, 48, 64, 72, 96\*

Rings: 1/16, 1/8, 1/4, 1/2, 1, 2, 3, 4, 6, 12, 16, 18, 24  
 Minimum Range 25 m on 0.25 nm range  
 Range Discrimination 20 m or better

Echo Trails  
 Type True or relative trails  
 Trail Length: 15, 30 sec., 1, 3, 6, 15, 30 min., 12, 24 hour., or continuous Trail

Trail Width: Narrow, Normal  
 Plotting Facilities (Required optional board ARP-11)  
 Acquisition: Auto, Manual

Number of targets: 10 targets in 0.1-16 nm

AIS Functions (Data input from AIS is required)

Symbols: Sleeping, Activated, Dangerous, Selected, Lost targets  
 Number of targets: 100 targets max.

**INTERFACE**

Input IEC 61162 NMEA0183 Ver. 1.5/2.0  
 Output IEC 61162 NMEA0183, Analog RGB video(option)

**ENVIRONMENT**

Temperature  
 Antenna Unit: -25°C to +70°C (-13°F to +158°F)  
 Display Unit: -15°C to +55°C (5°F to +131°F)  
 Waterproofing  
 Antenna Unit: IEC60529 IPX6  
 Display Unit: IEC60529 IPX5 (front panel)

**POWER SUPPLY**

FR-8062: 10.8-31.2 VDC, 3.2A\*  
 FR-8122: 10.8-31.2 VDC, 3.8A\*  
 FR-8252: 10.8-31.2 VDC, 5.0A\*  
 \*24VDC (windless)

**EQUIPMENT LIST**

- Standard**
- |   |        |
|---|--------|
| 1. Display Unit                           | 1 unit |
| 2. Antenna Unit (Specify when ordering)   | 1 unit |
| 3. Antenna Cable 10, 15, 20 or 30 m       | 1 pc.  |
| 4. Power Cable 3.5 m                      | 1 pc.  |
| 5. Power Supply Unit for FR-8252          | 1 unit |
| 6. Installation materials and spare parts | 1 set  |
- Option**
- |   |  |
|---|--|
| 1. Rectifier  | RU-3423  |
| 2. Interface Cable  | MJ-A7SPF0007-050C, 5 m<br>MJ-A6SPF0007-100, 10 m |
| 3. External Alarm Buzzer  | OP03-136   |
| 4. Auto Plotter   | ARP-11 (built in display unit)                   |
| 5. Gyro Converter   | AD-100   |
| 6. AIS Interface Unit   | IF-1500AIS                                       |
| 7. Analog RGB Video Output Kit for remote display (built in display unit) |  |
| 8. Remote Control   | RCU-019-E  |

**Display Unit**

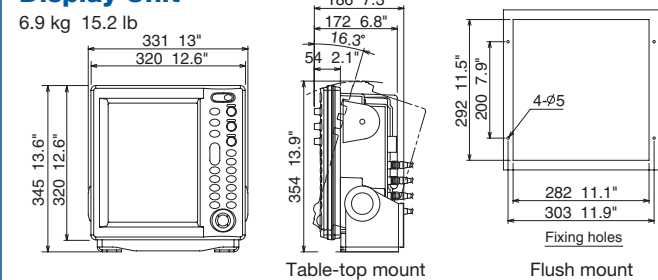

**Antenna Unit**

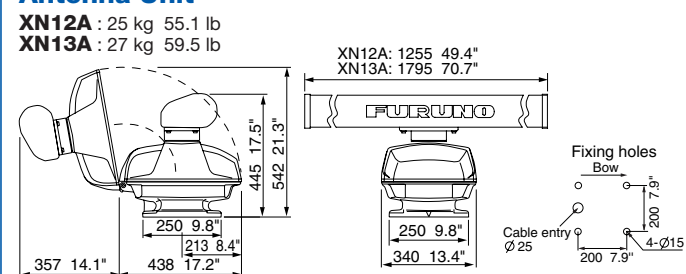

**Power Supply Unit**

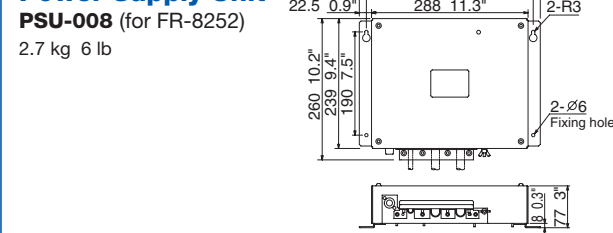

All brand and product names are registered trademarks, trademarks or service marks of their respective holders.

SPECIFICATIONS SUBJECT TO CHANGE WITHOUT NOTICE

12.1" Multi-Color LCD RADAR

FR-8062/8122/8252

[ 6 kW ]

[ 12 kW ]

[ 25 kW ]

Optimized detection with variable antenna rotation speed

- ▶ 12.1" SVGA color TFT LCD with echo colors of 32 levels
- ▶ Superior short range target detection capability
- ▶ Advanced auto modes to automatically adjust gain, tuning and AC rain/sea for delivering the best available picture
- ▶ 48 rpm antenna for high-speed craft as well as for river use
- ▶ True motion echo trail
- ▶ Up to three programmable radar settings can be selected to give the best radar performance in different sea conditions
- ▶ Auto plotter ARP-11 for automatic acquisition and tracking of 10 targets (option)
- ▶ Displays up to 100 AIS targets on the screen (with optional AIS interface.)



**INTERCONNECTION DIAGRAM**

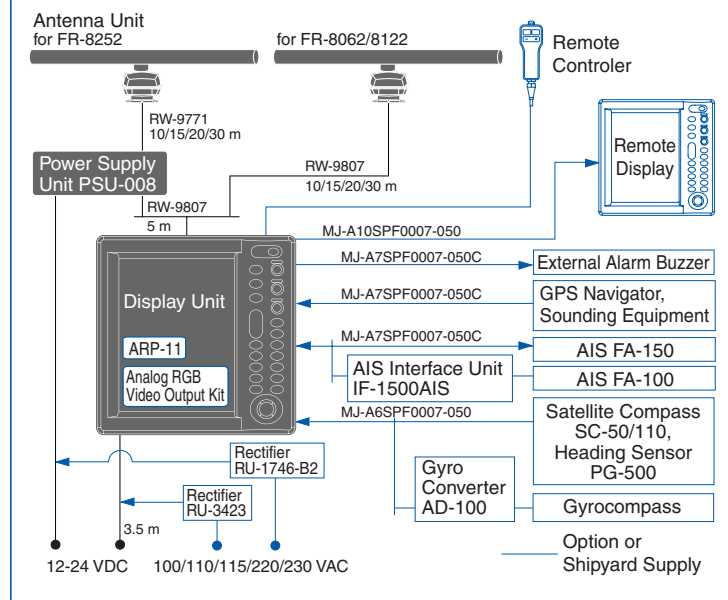

**FURUNO ELECTRIC CO., LTD.**  
 Nishinomiya, Hyogo, Japan  
 www.furuno.co.jp

**FURUNO U.S.A., INC.**  
 Camas, Washington, U.S.A.  
 www.furunousa.com

**FURUNO (UK) LIMITED**  
 Havant, Hampshire, U.K.  
 www.furuno.co.uk

**FURUNO FRANCE S.A.S.**  
 Bordeaux-Mérignac, France  
 www.furuno.fr

**FURUNO ESPAÑA S.A.**  
 Madrid, Spain  
 www.furuno.es

**FURUNO DANMARK AS**  
 Hvidovre, Denmark  
 www.furuno.dk

**FURUNO NORGE A/S**  
 Ålesund, Norway  
 www.furuno.no

**FURUNO SVERIGE AB**  
 Västra Frölunda, Sweden  
 www.furuno.se

**FURUNO FINLAND OY**  
 Espoo, Finland  
 www.furuno.fi

**FURUNO POLSKA Sp. z o.o.**  
 Gdynia, Poland  
 www.furuno.pl

**FURUNO DEUTSCHLAND GmbH**  
 Rellingen, Germany  
 www.furuno.de

**FURUNO EURUS LLC**  
 St. Petersburg, Russian Federation  
 www.furuno.com.ru

**FURUNO HELLAS LTD.**  
 Piraeus, Greece



# FURUNO's new high-performance FR-8002 series fully complies with the IEC testing standard for small radar

The FURUNO FR-8002 series is a new 12.1" color radar that displays high quality radar images. The FR-8002 series fully complies with IEC 62252 testing standard for small radar to enhance the safety of your boating life.

The FR-8002 series radar presents outstanding short-range detection capability, detecting objects at the range of 20 m. The distance resolution is as fine as 15 m, helping to distinguish small targets in congested waterways. The maximum detection range has been greatly extended, thanks to the high sensitivity of its antenna radiator.

In addition, its high antenna rotation speed, of 48 rpm, allows the FR-8002 to be utilized on high speed craft and river vessels. The antenna rotation speed can be automatically adjusted according to the selected range scale. The range scale of this radar series can also be switched to display kilometers for use in rivers.



## User friendly Control Knobs

Control knobs for fine adjustment of gain, anti-clutter rain and sea.



## Advanced Auto Mode



The FR-8002 series is capable of constantly presenting the best possible pictures by simply pressing the respective knobs. The advanced auto mode automatically adjusts the tuning, gain and anti clutter controls. These settings can also be manually adjusted by turning the respective knobs on the front panel.

## User Customized Modes



When the vessel is on a regular route or under circumstances such as heavy rain and rough seas where special radar settings are required, the operator may simply press the CUSTOM key to activate the user-customized operating mode. Up to three programs can be registered with specific settings for clutter controls and unwanted echo suppression, antenna rotation speed, etc., according to the given situation and specific usage.

## Choice Of Antenna Units

The FR-8002 series offers flexibility in its utilization for river-use, as well as, high-speed craft with its high speed antenna rotation. The antenna rotation speed can automatically be adjusted according to the selected range scale for optimum detection.

|         | Antenna rotation speed | Output power | Antenna length      |
|---------|------------------------|--------------|---------------------|
| FR-8062 | 24/36/48 rpm           | 6 kW         | Either 4 ft or 6 ft |
| FR-8122 | 24/36/48 rpm           | 12 kW        |                     |
| FR-8252 | 24/36/48 rpm           | 25 kW        |                     |

## True Motion Echo Trail

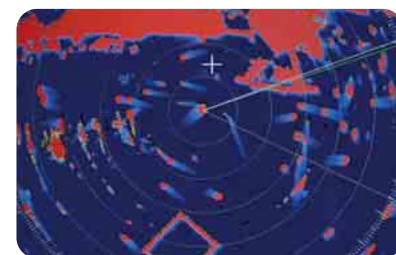

When connected with a heading sensor and position receiver, i.e. GPS, the FR-8002 series can display True Echo Trails to present true target movements in accordance with their speed-over-ground and course-over-ground. This mode provides intuitive monitoring of moving targets.

## Zoom Mode

There are three zoom modes available for the FR-8002 series to highlight a selected area in a pop-up window, which are relative, true and target zoom. With the target zoom mode, a selected ARP/AIS target is shown and tracked in a zoomed-in window.

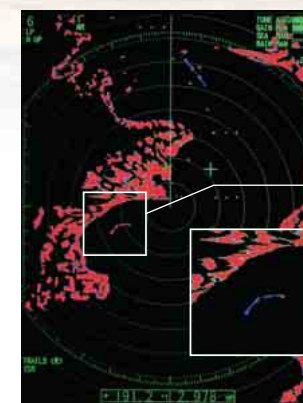

Selected zoom area

Pop-up window

## ARP/AIS

With the optional ARP board ARP-11, up to 10 targets can be acquired and tracked on the radar screen. Additionally, up to 100 AIS targets can be presented with appropriate AIS data input. Detailed information on up to two ARP/AIS targets can be displayed in the data cells at the bottom of the screen.

AIS Target

ARP Target

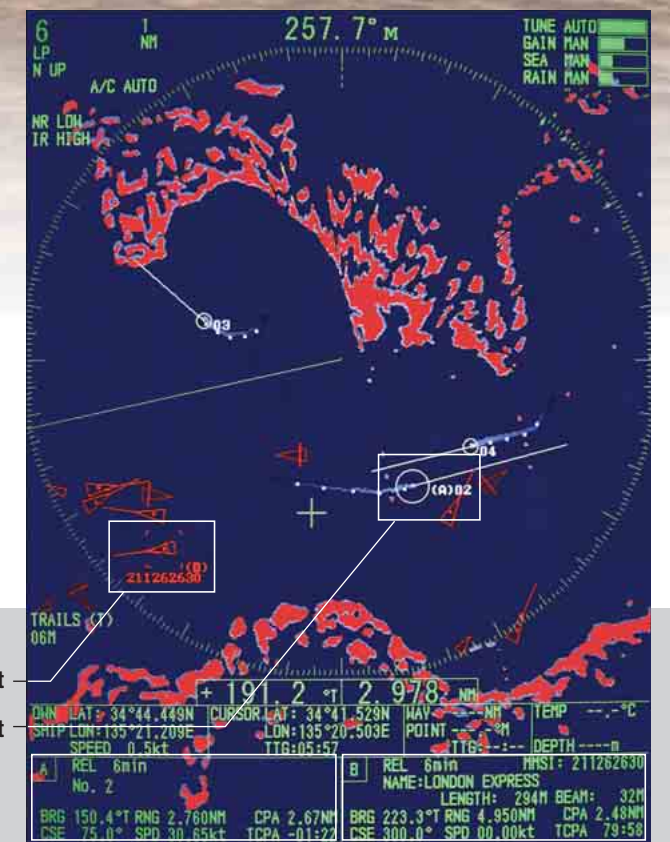

Data Cell A : ARP Information

Data Cell B : AIS Information

In this brochure, the echo images go beyond the outer most ring and cover the data area. The FR-8002 series does that to present wider overview of the surrounding area. The FR-8002 series can also restrict the presentation of echo images within the ring as in the ordinary radar setting.